

Maximum Sizes and Configurations

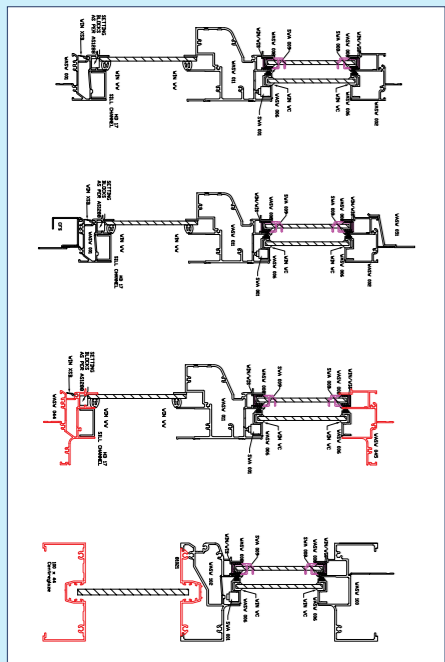

Full size drawings available

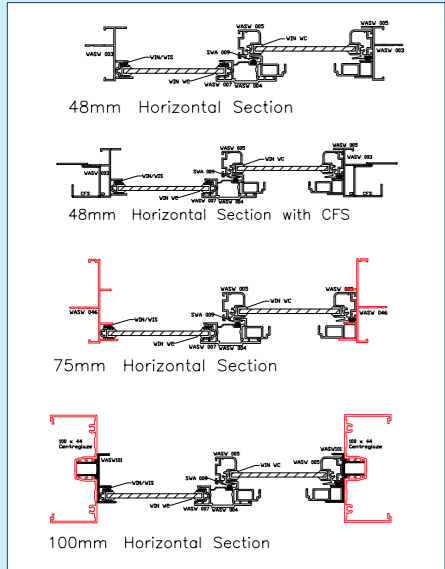

Full size drawings available



Please see our performance glass brochure for detailed glazing options for your windows

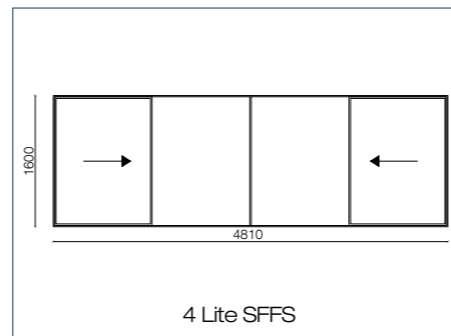
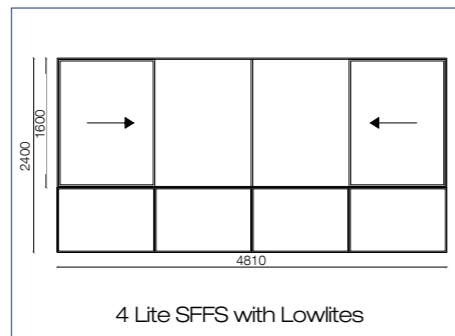
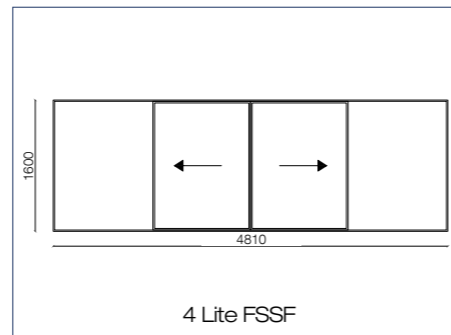
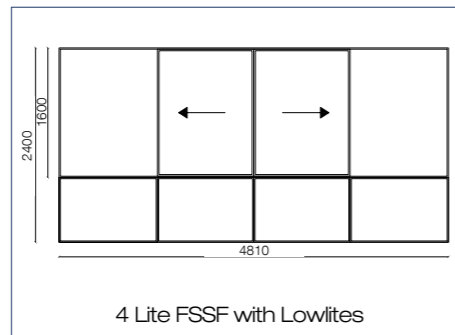
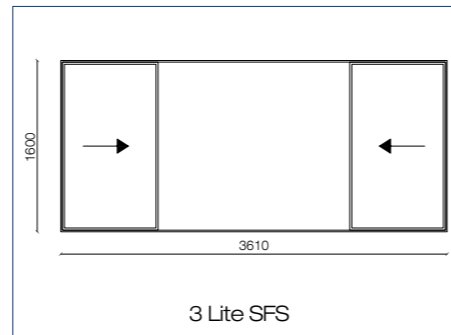
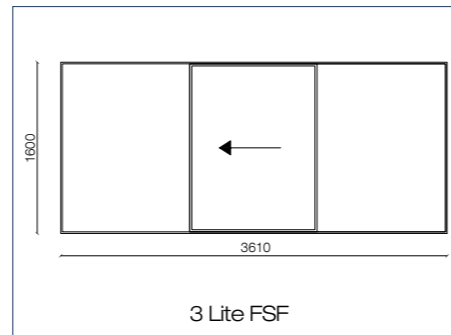
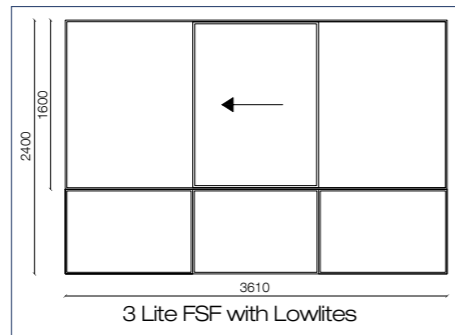
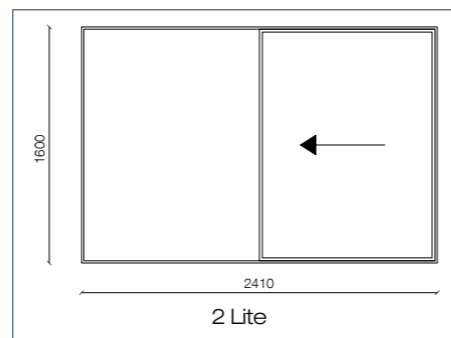
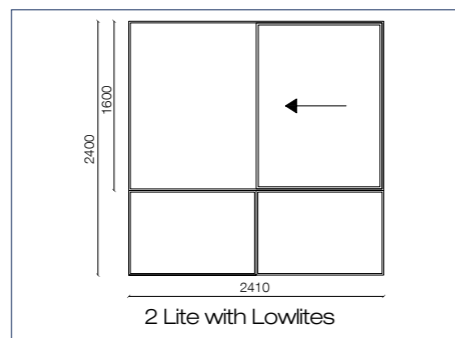

mandurahglass

Australian Designed and Locally Made

Sliding Windows



Call us for custom sizing or specific requirements

21 Tindale Street, Mandurah 6210, Ph: 9581 2894, Fax: 9581 5009
Web: www.mandurahglass.com.au Email: info@mandurahglass.com.au

Residential | Commercial | Architectural



Mandurah Glass custom measure and manufacture the Wintec range of sliding windows to suit your individual specifications.

Benefits;

- Ideal in locations where there is restricted space.
- Frames have smooth lines to ensure cleaning is easier and no internal projections to catch on window treatments.
- Ease of operation and longer lasting performance with exclusive heavy duty double rollers. They also enable larger than usual sashes to be used.
- Suitable for all glass types and building materials.
- Can be adapted to all Western Australian wind load categories.
- Large variety of colours and configurations possible.
- Keylocks available.
- Flyscreens can be fitted to the frame without unsightly rivets, metal clips or turn buckles.

Options;

- Exclusive cladding adaptor available that conceals your cladding ends in to the window frame.
- Integrated security upgrades available for your locks and screens plus anti lift blocks.
- Glass upgrades can include double glazing and smart glass.
- Upgrade to the commercial range for dedicated high performance systems where larger windows and/or high wind load areas have been specified.



sliding windows

Sliding windows are very economical and the ultimate in reliable, low maintenance windows due to their few moving parts

Visit our website www.mandurahglass.com.au or call us on 08 9581 2894

See our entire range at 21 Tindale Street, Mandurah 6210